

STAGE 1 box 1

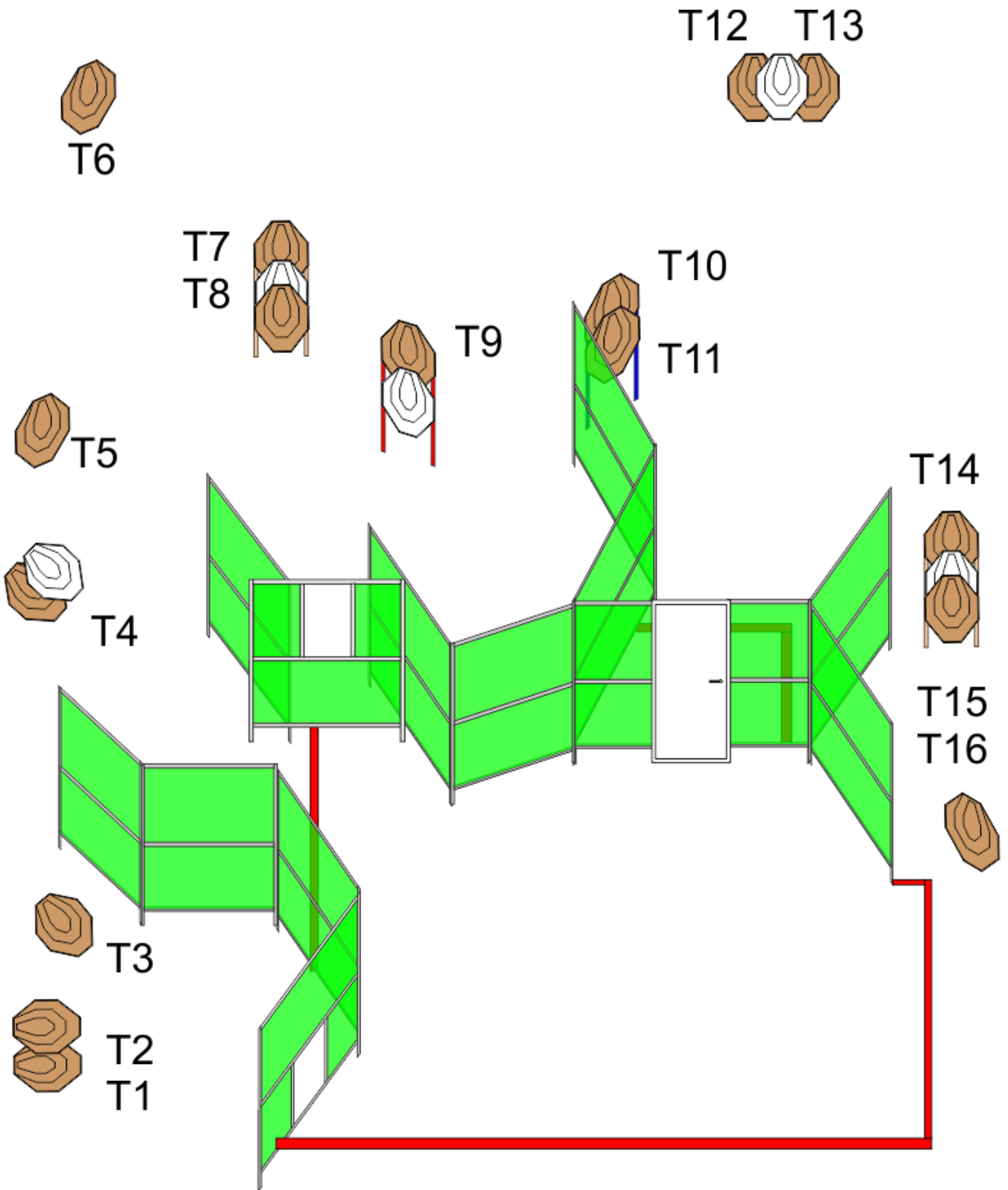

Targets:	16 x IPSC Targets
Rounds to be scored:	32
Starting position:	The shooter is standing inside the marked area.
Handgun Ready condition:	
Procedure:	After audible signal engage the targets.
Safe angles of fire:	Reduced to the height of the backstops and left by flag.

STAGE 2 box 2

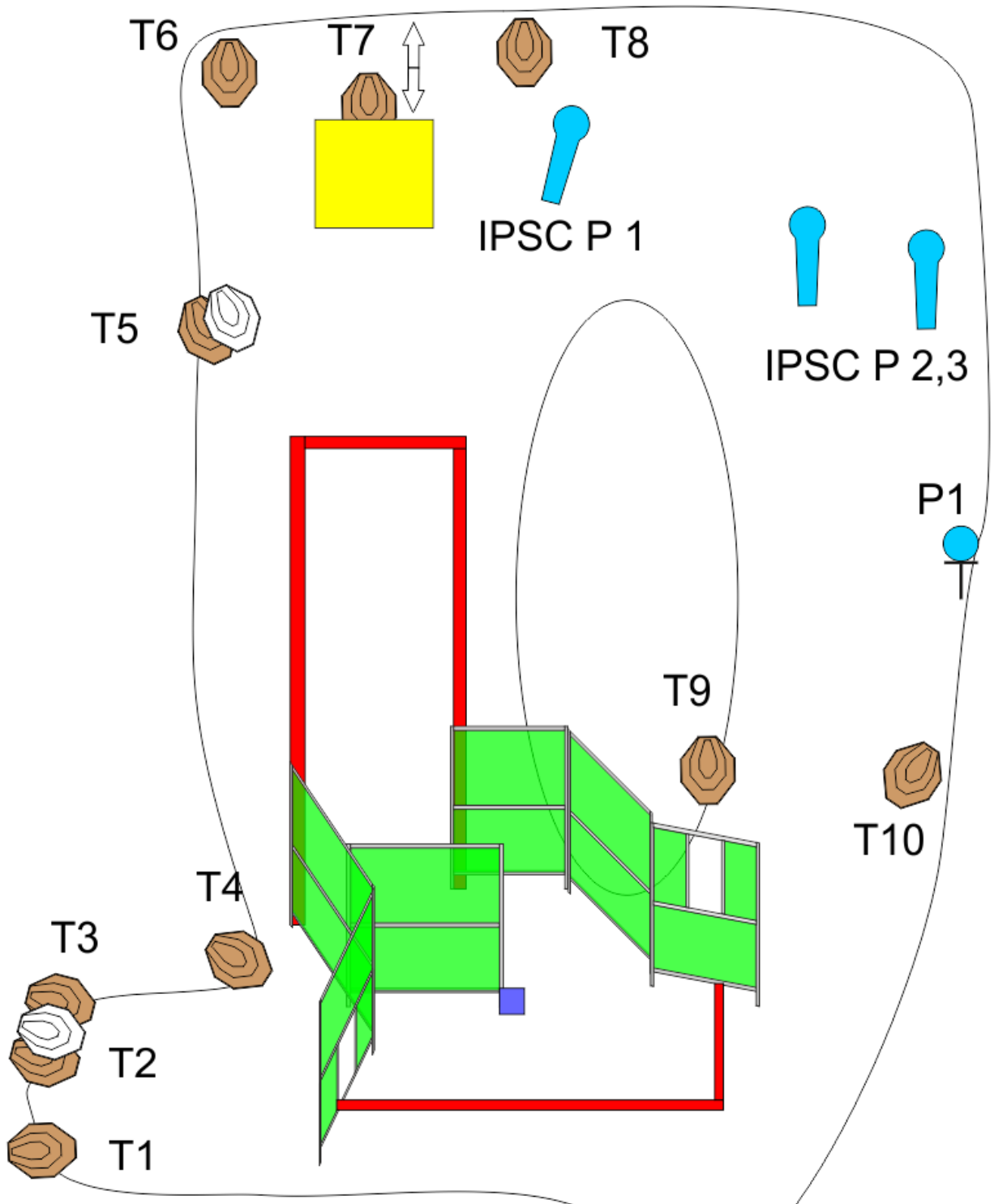

Targets:	10x IPSC Targets, 3 x IPSC Poppers, 1 x IPSC Metal Plate
Rounds to be scored:	24
Starting position:	The shooter is standing inside the marked area. Left foot touching blue line.
Handgun Ready condition:	
Procedure	After audible signal engage the targets. IPSC Popper 1 activates T 7. Targets will remain visible at rest.
Safe angles of fire:	Reduced to the height of the backstops.

STAGE 3 box 3

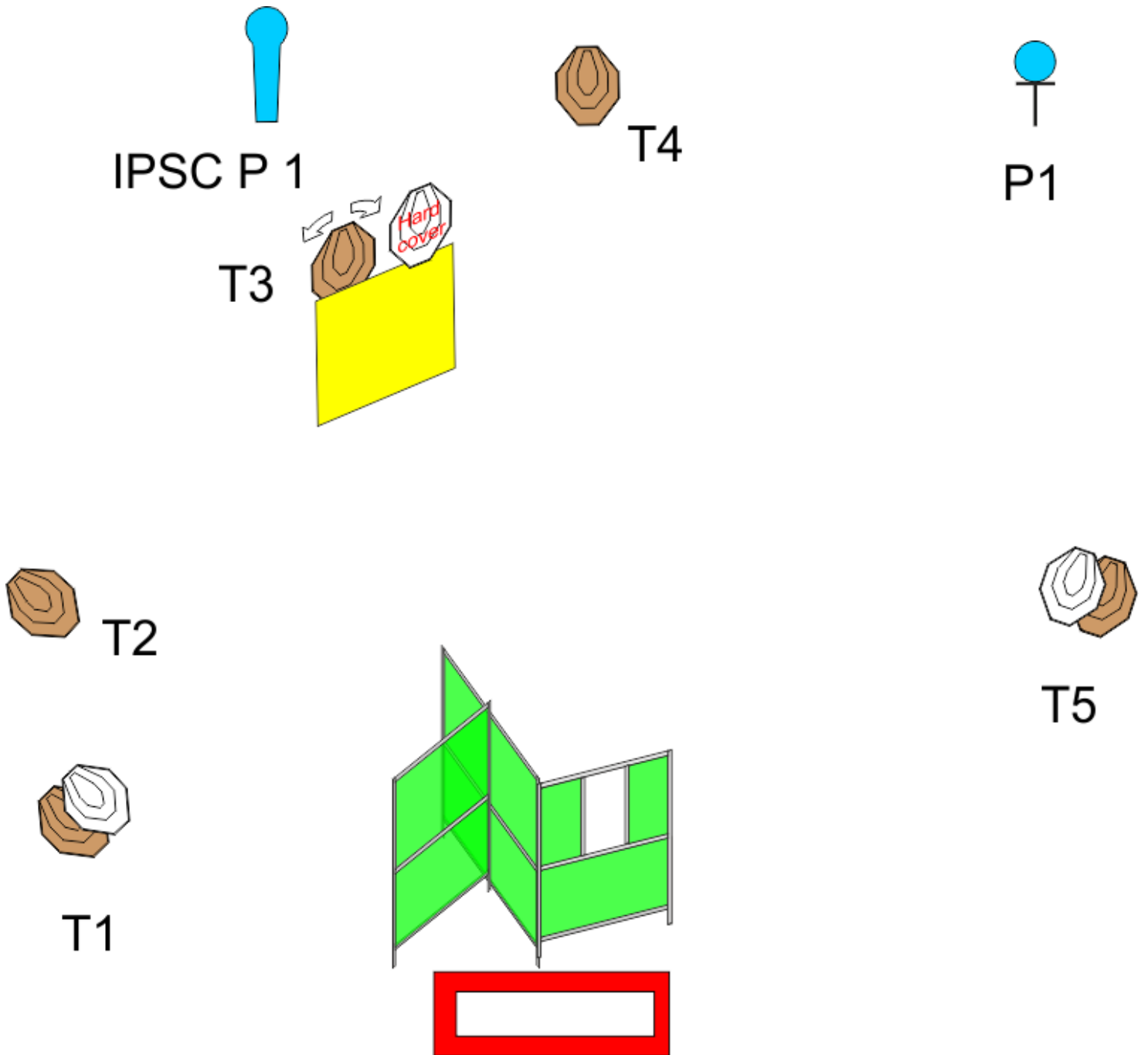

Targets:

5x IPSC Targets, 1x IPSC Popper, 1X IPSC Metal Plate

Rounds to be scored:

24

Starting position:

The shooter is standing inside the marked area.

Handgun Ready condition:

Procedure:

After audible signal engage the targets. IPSC Popper 1 activates T 3. Target will remain visible at rest..

Safe angles of fire:

Reduced to the height of the backstops.

STAGE 4 box 4

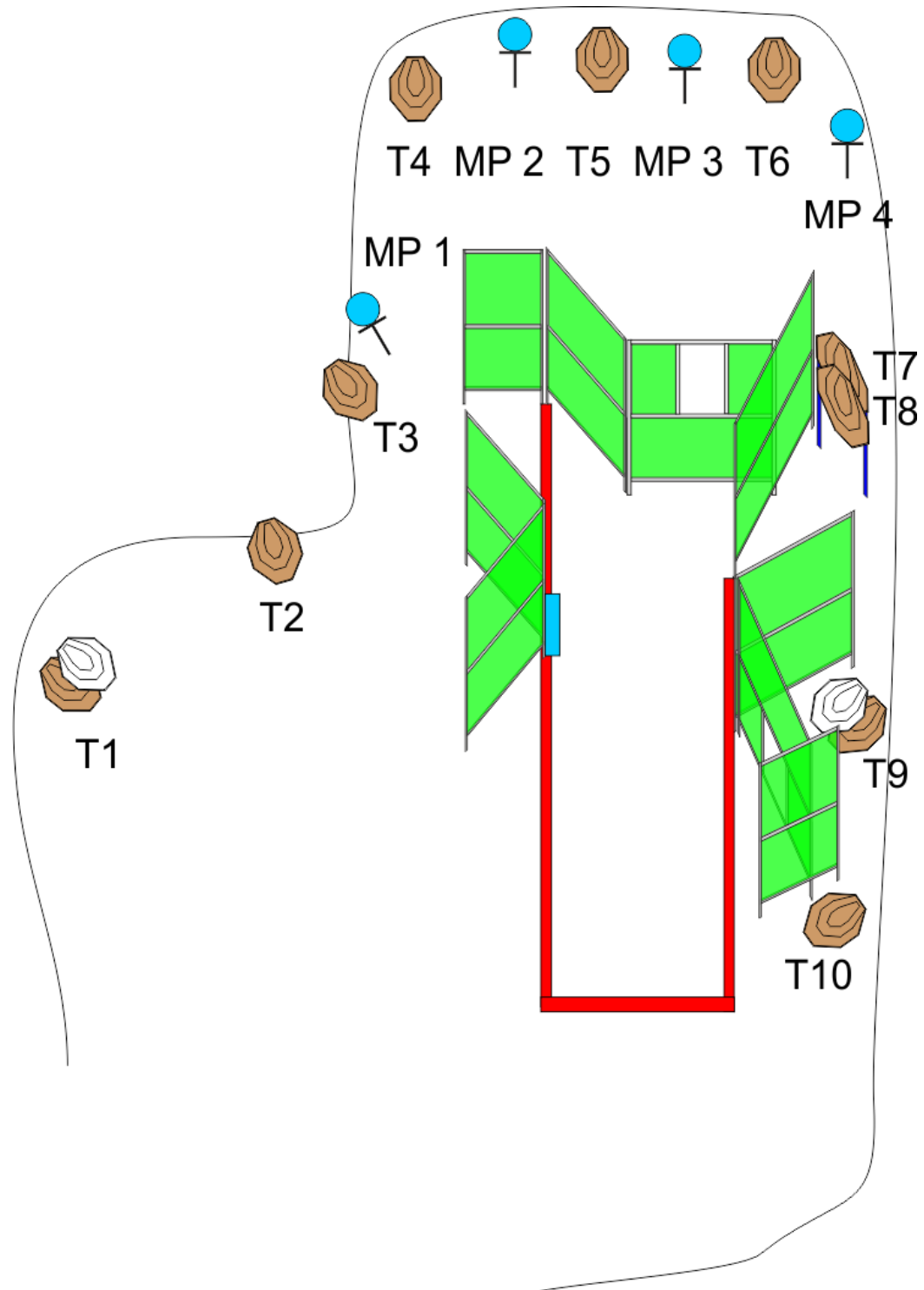

Targets:	10x IPSC Targets, 4x IPSC Metal Plates,
Rounds to be scored:	24
Starting position:	The shooter is standing inside the marked area. Left foot touching blue line
Handgun Ready condition:	
Procedure:	After audible signal engage the targets.
Safe angles of fire:	Reduced to the height of the backstops.

STAGE 5 box 5, 6



IP 1



MP 1

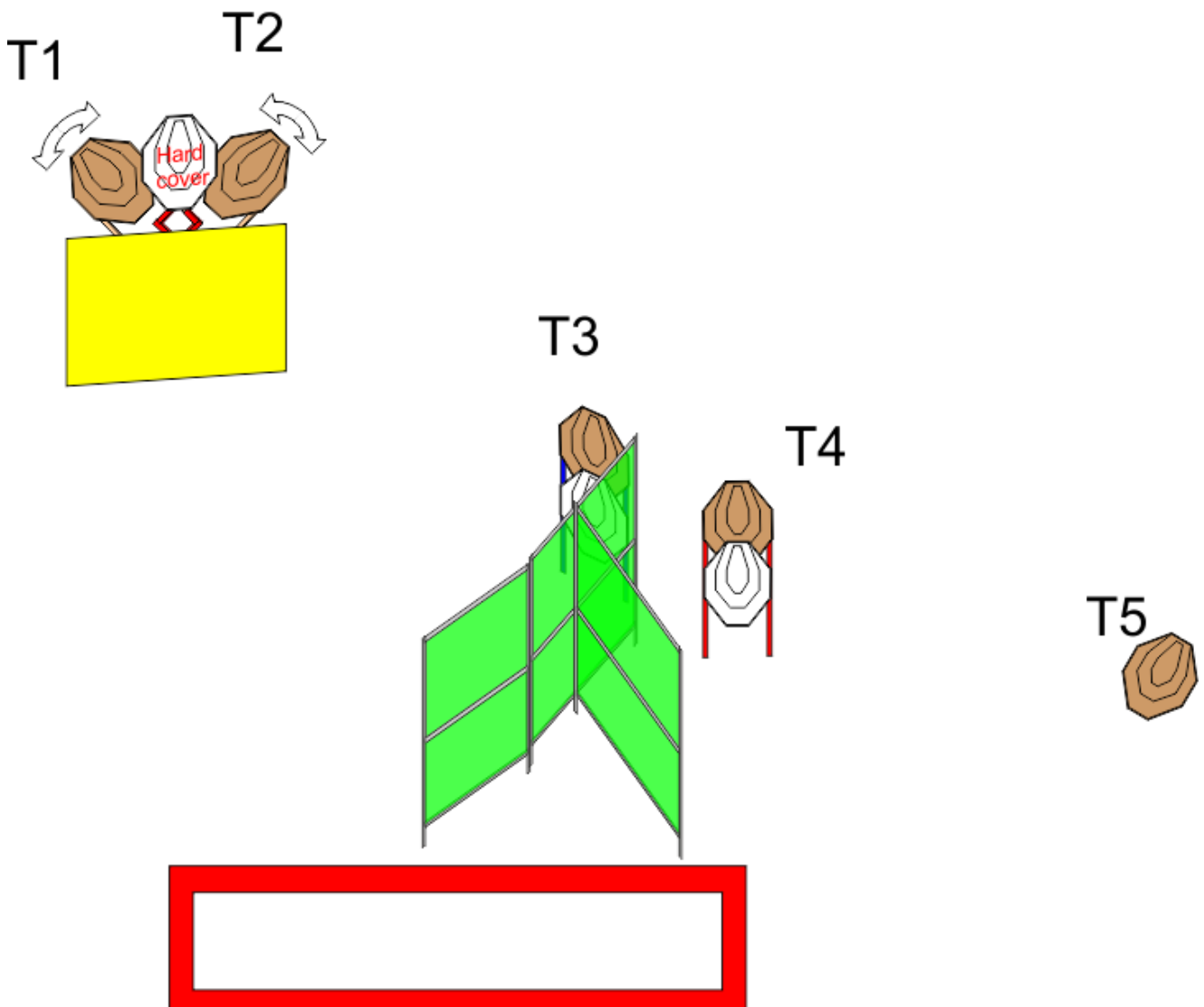

Targets:	5x IPSC Targets, 1 x IPSC Popper, 1x IPSC Metal Plate
Rounds to be scored:	12
Starting position:	The shooter is standing inside the marked area.
Handgun Ready condition:	
Procedure:	After audible signal engage the targets. IPSC Popper 1 activates T1,2. Target will remain visible at rest..
Safe angles of fire:	Reduced to the height of the backstops.

STAGE 6 box 7, 8

IPSC P 1



IPSC P 2

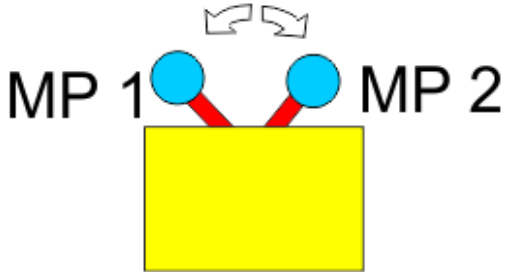

T2



T3



T1

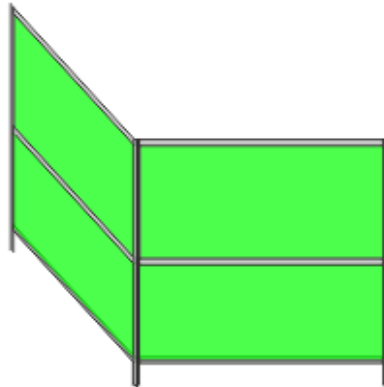

T4



Targets:	4x IPSC Targets, 2x IPSC Poppers, 2 x Metal Plates
Rounds to be scored:	12
Starting position:	The shooter is standing inside the marked area.
Handgun Ready condition:	
Procedure:	After audible signal engage the targets. IPSC Popper 1 activates MP 1,2. Metal plates will remain visible at rest
Safe angles of fire:	Reduced to the height of the backstops.

STAGE 7 box 9

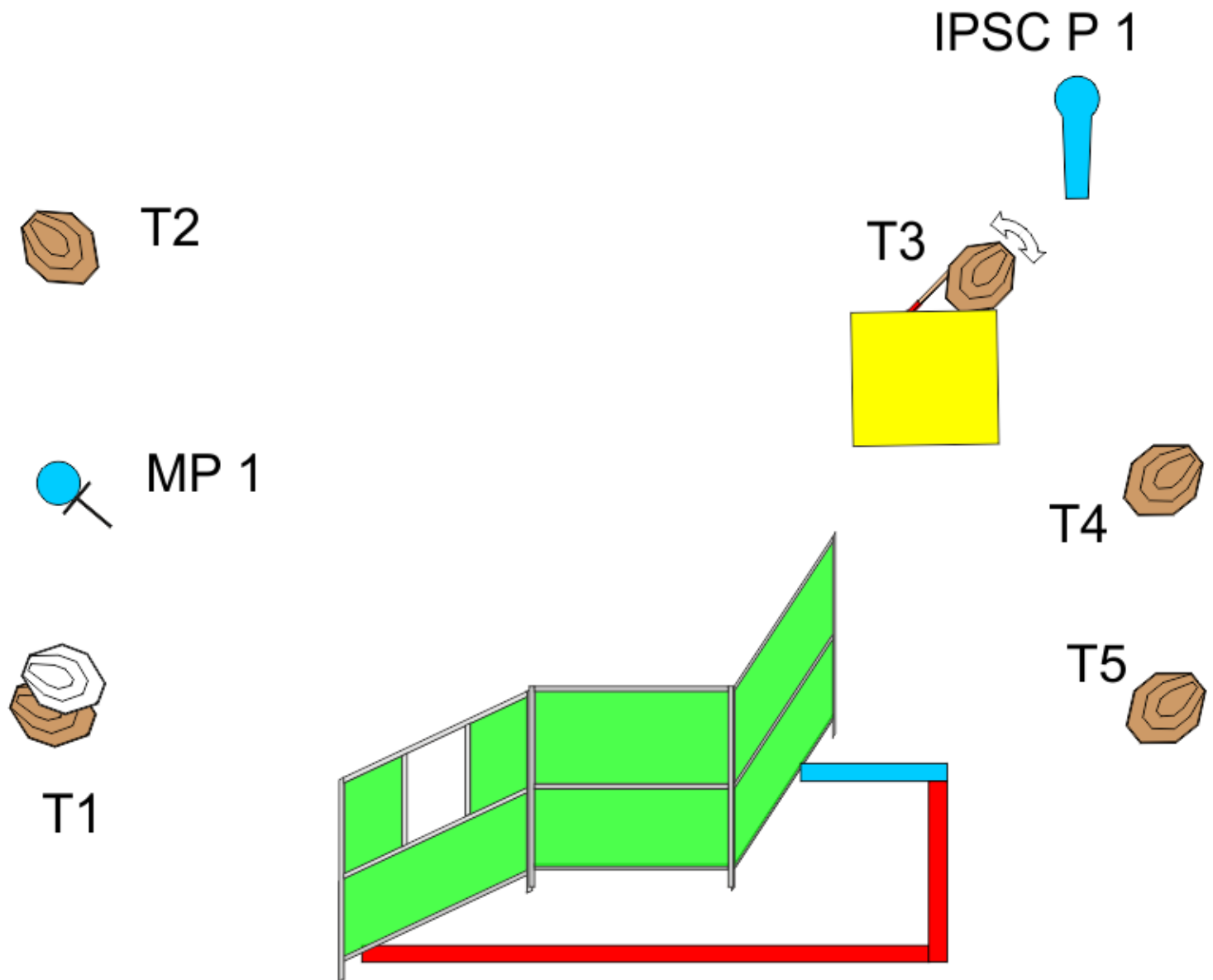

Targets:	5x IPSC Targets, 1x IPSC Popper, 1x IPSC Metal Plate
Rounds to be scored:	12
Starting position:	The shooter is standing inside the marked area. Toes touching blue line.
Handgun Ready condition:	
Procedure:	After audible signal engage the targets IPSC Popper 1 activates T3. Targets will remain visible at rest.
Safe angles of fire:	Reduced to the height of the backstops.

STAGE 8 box 10

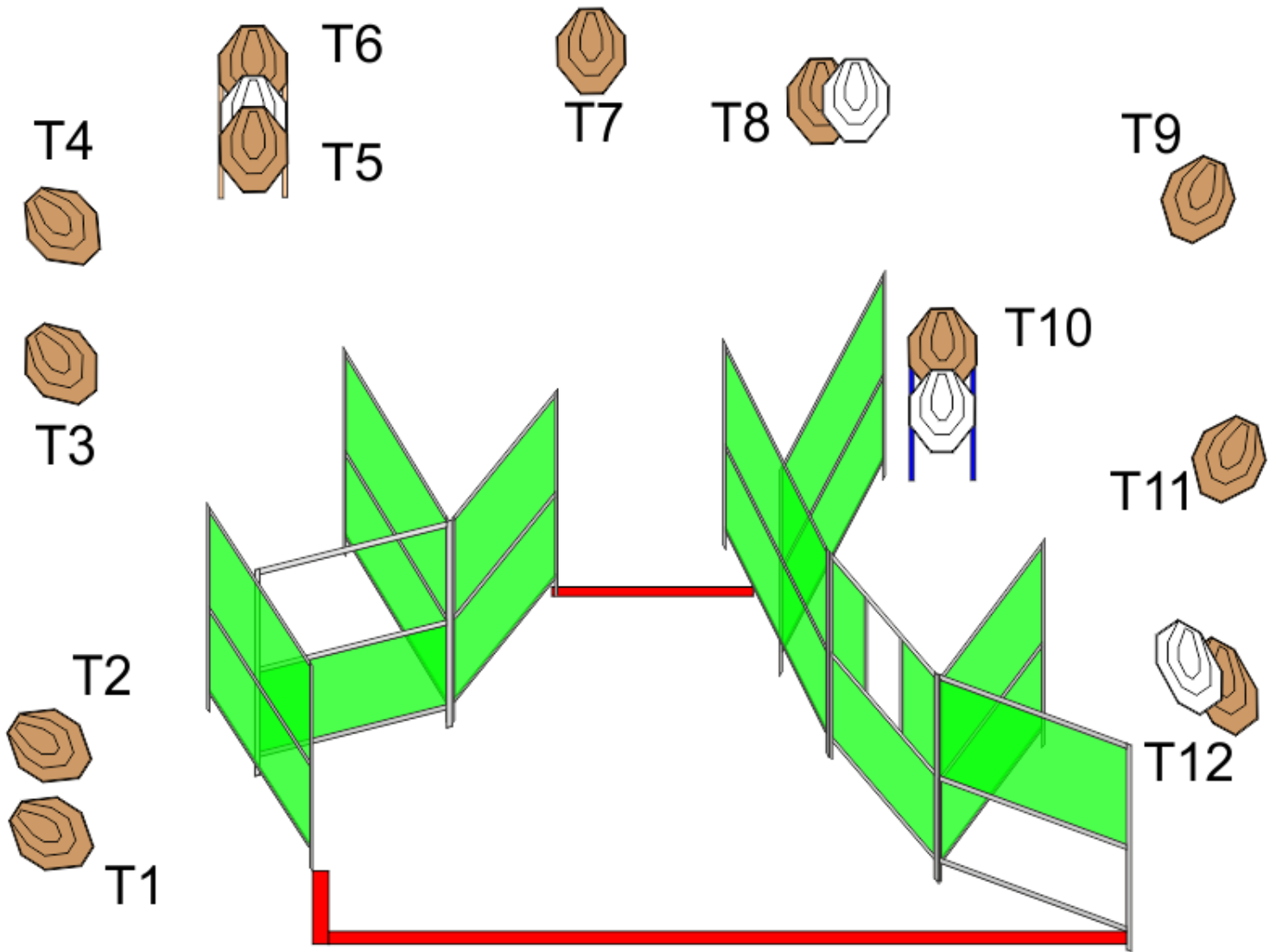

Targets:	12 x IPSC Targets
Rounds to be scored:	24
Starting position:	The shooter is standing inside the marked area.
Handgun Ready condition:	
Procedure:	After audible signal engage the targets.
Safe angles of fire:	Reduced to the height of the backstops.

STAGE 9 box 11

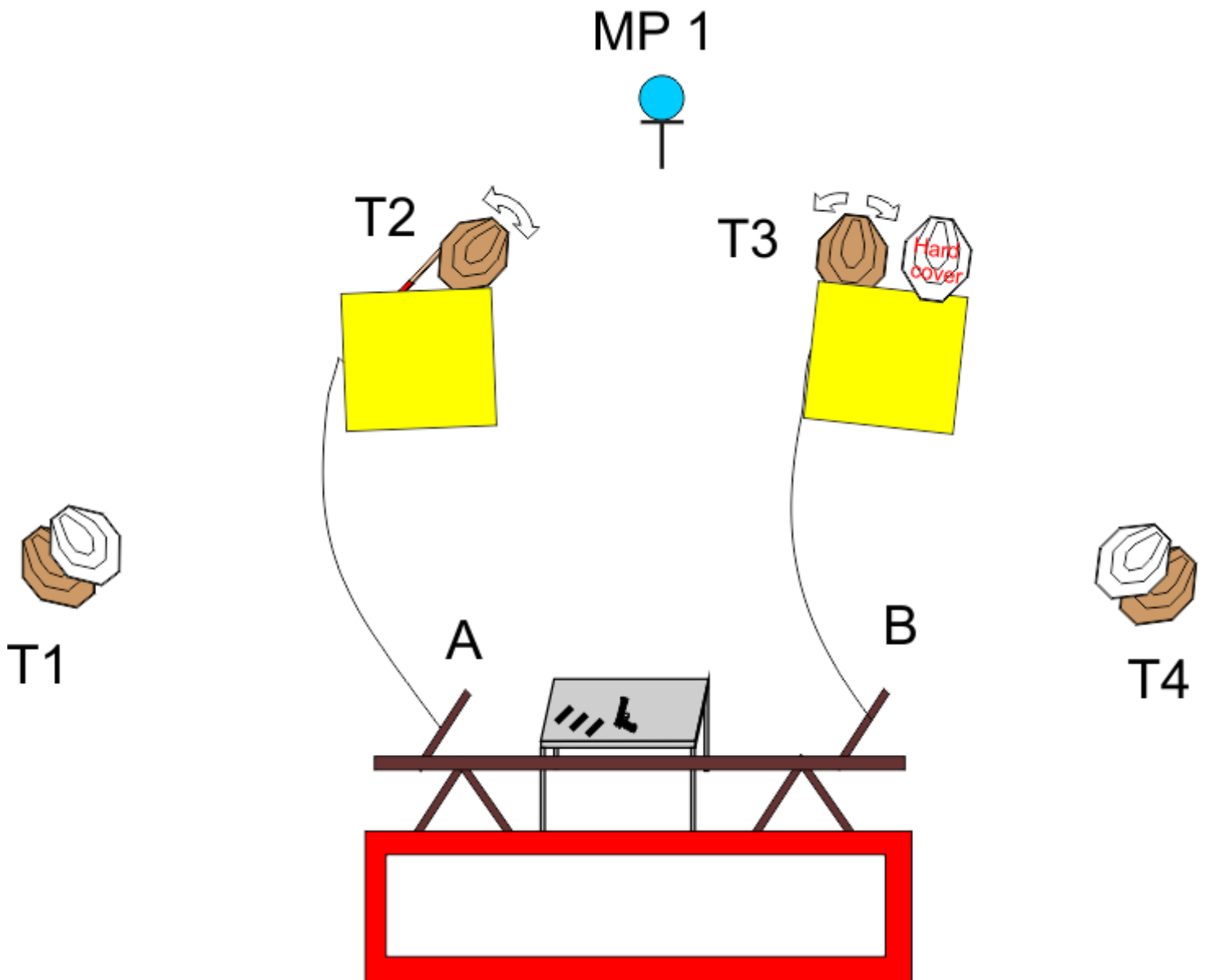

Targets:	4x IPSC Targets, 1x IPSC Metal Plate
Rounds to be scored:	9
Starting position:	The shooter is standing inside the marked area.
Handgun Ready condition:	Gun is lying on the table, chamber and magwell empty, all magazines on the table, none on the belt.
Procedure:	After audible signal engage the targets .Rod A activates T2, rod B activates T3. Targets will remain visible at rest.
Safe angles of fire:	Reduced to the height of the backstops.

STAGE 10 box 12

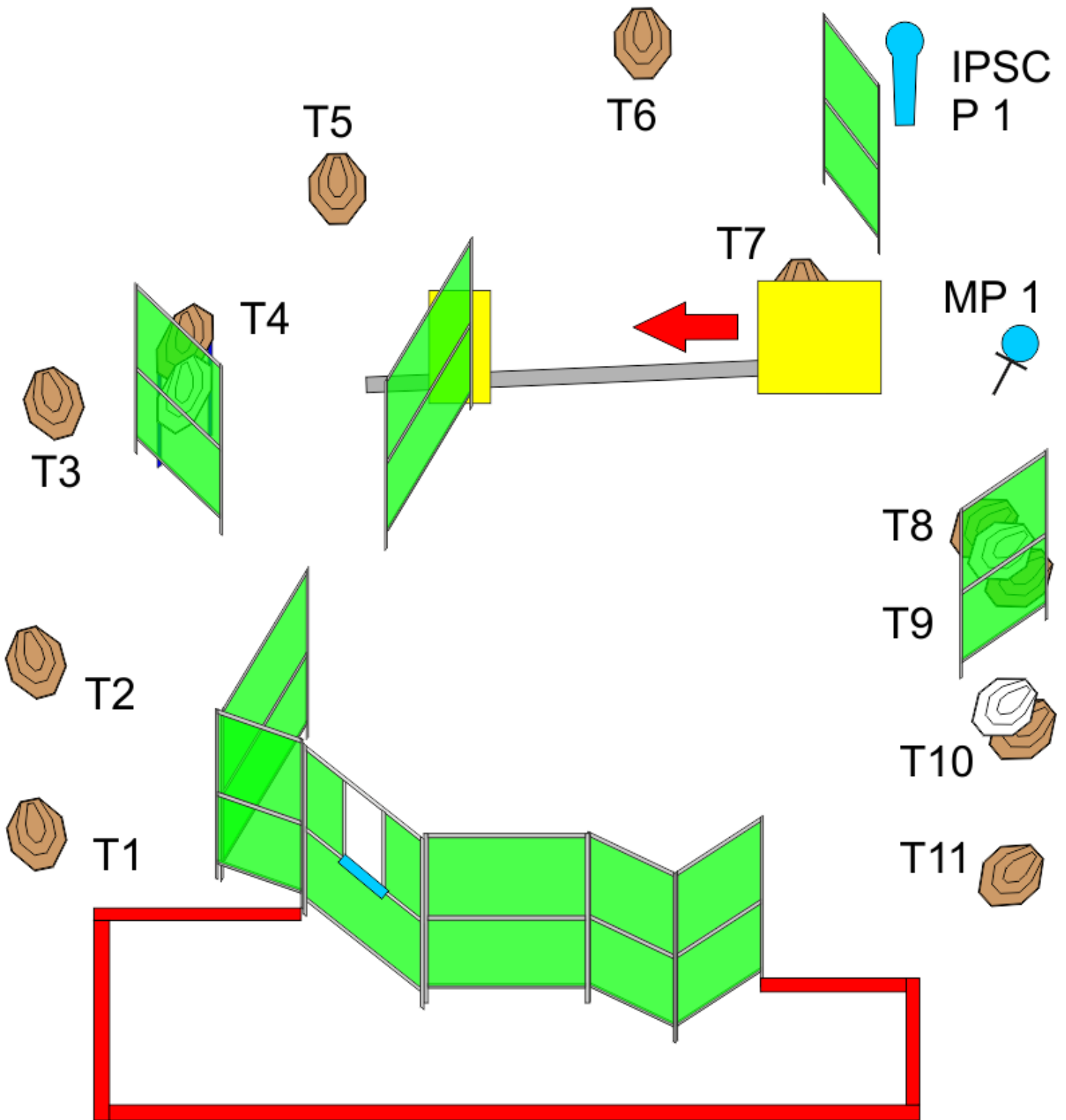

Targets:	11 x IPSC Targets, 1x IPSC Popper, 1x IPSC Metal Plate
Rounds to be scored:	24
Starting position:	The shooter is standing inside the marked area. One hand touching blue line.
Handgun Ready condition:	
Procedure:	After audible signal engage the targets. IPSC Popper 1 activates T 7. Target will remain visible at rest.
Safe angles of fire:	Reduced to the height of the backstops.

STAGE 11 box 13

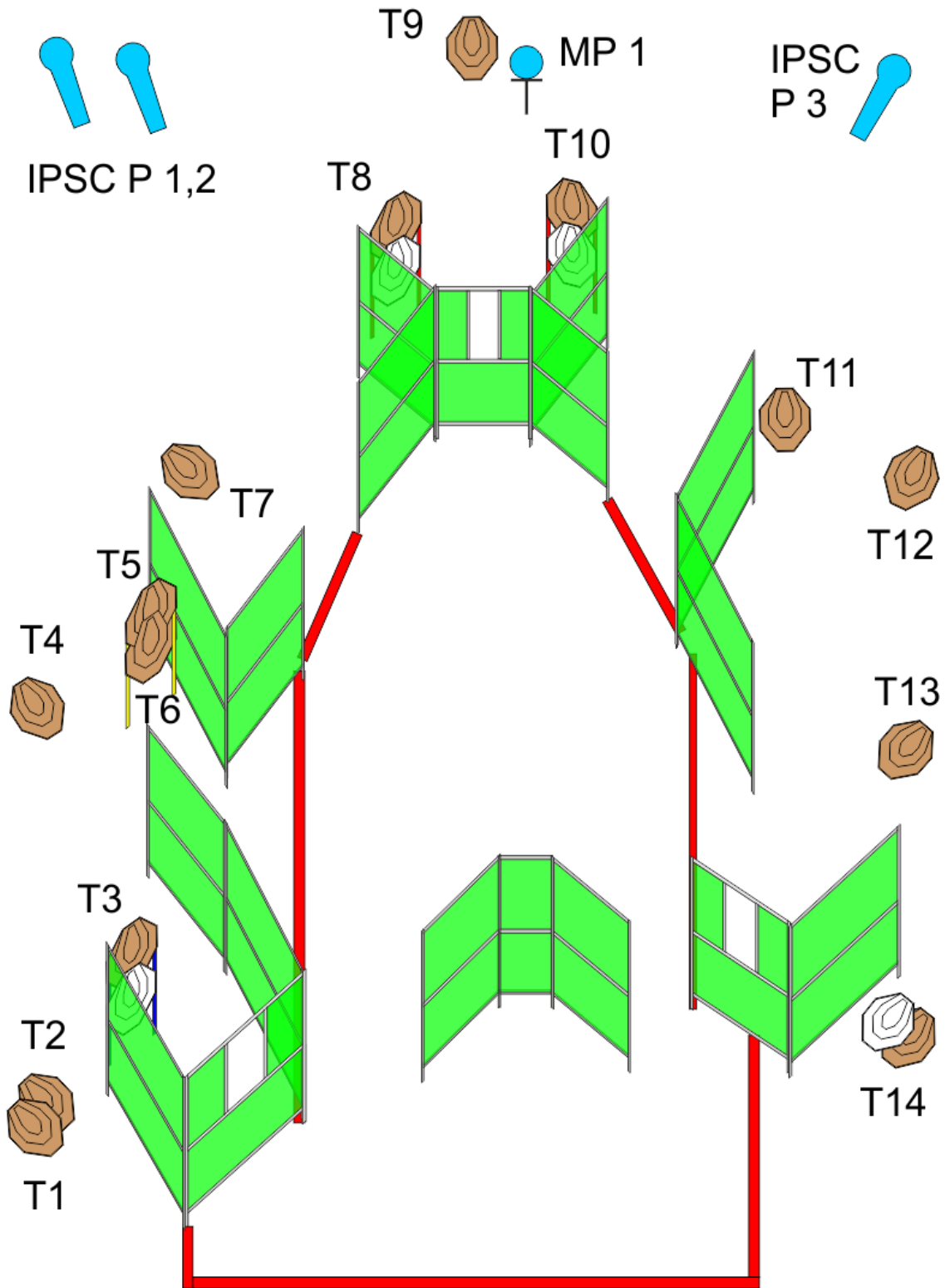

Targets:	14x IPSC Targets, 3x IPSC Poppers, 1 x IPSC Metal Plates
Rounds to be scored:	32
Starting position:	The shooter is standing inside the marked area.
Handgun Ready condition:	
Procedure:	After audible signal engage the targets
Safe angles of fire:	Reduced to the height of the backstops.

STAGE 12 box 14

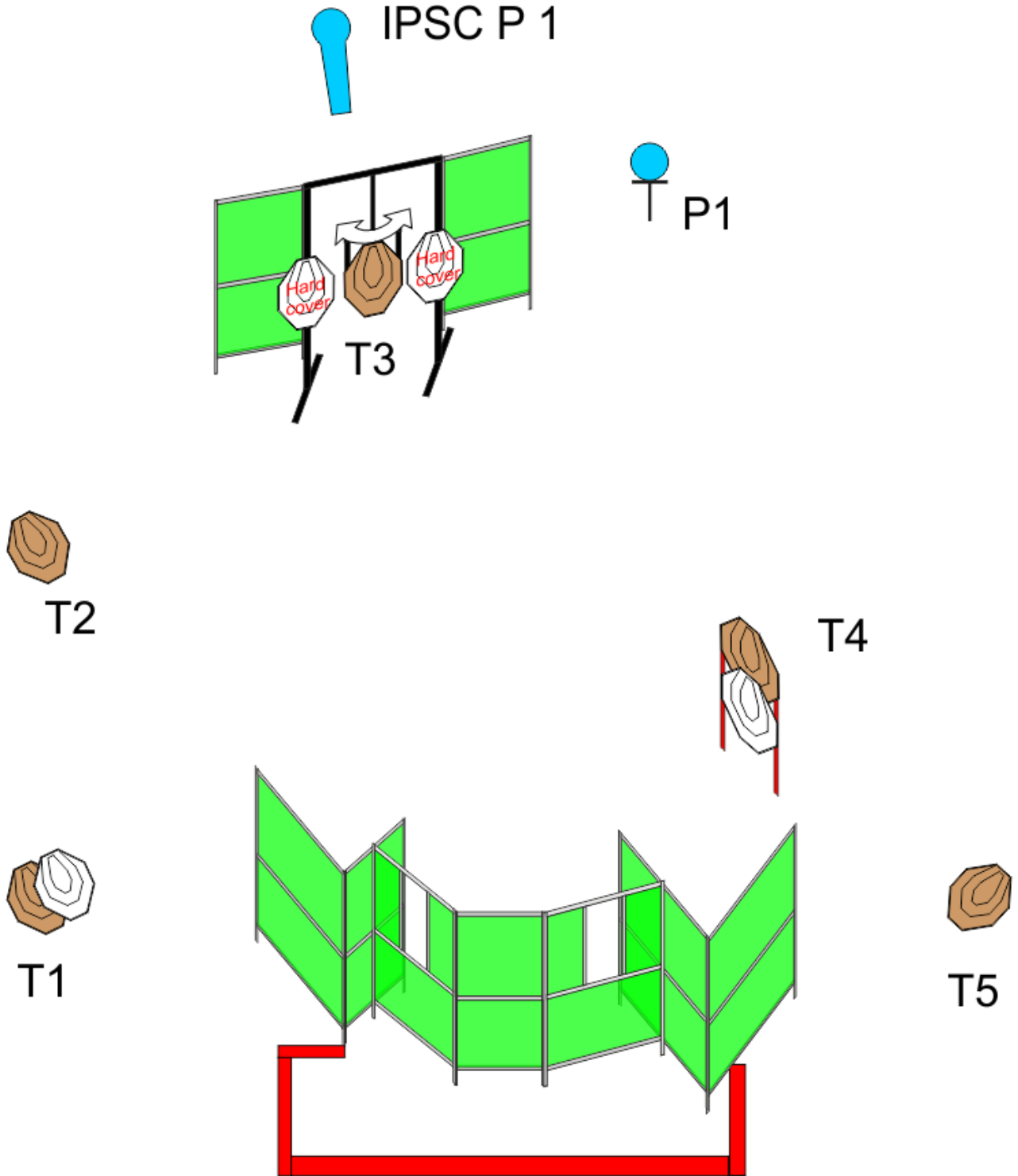

Targets:	5x IPSC Targets, 1x IPSC Popper, 1x Metal Plate
Rounds to be scored:	12
Starting position:	The shooter is standing inside the marked area.
Handgun Ready condition:	
Procedure:	After audible signal engage the targets, IPSC Popper 1 activates T3. Targets will remain visible at rest.
Safe angles of fire:	Reduced to the height of the backstops.

STAGE 13 box 17

IPSC P 2,3



IPSC P 1

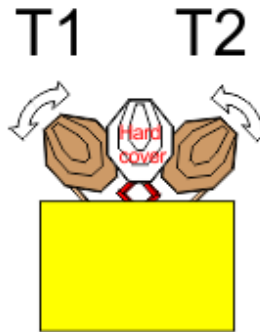

T3

P1



T4

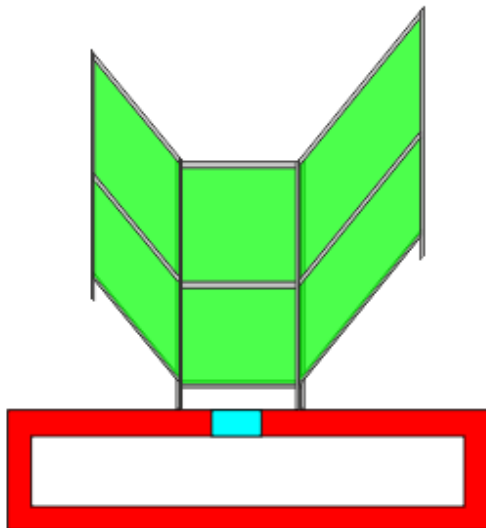

Targets:	4x IPSC Targets, 3x IPSC Poppers, 1x Metal Plate
Rounds to be scored:	12
Starting position:	The shooter is standing inside the marked area.
Handgun Ready condition:	
Procedure:	After audible signal engage the targets, IPSC Popper 1 activates T1, T2. Targets will remain visible at rest.
Safe angles of fire:	Reduced to the height of the backstops.

STAGE 14 box 18

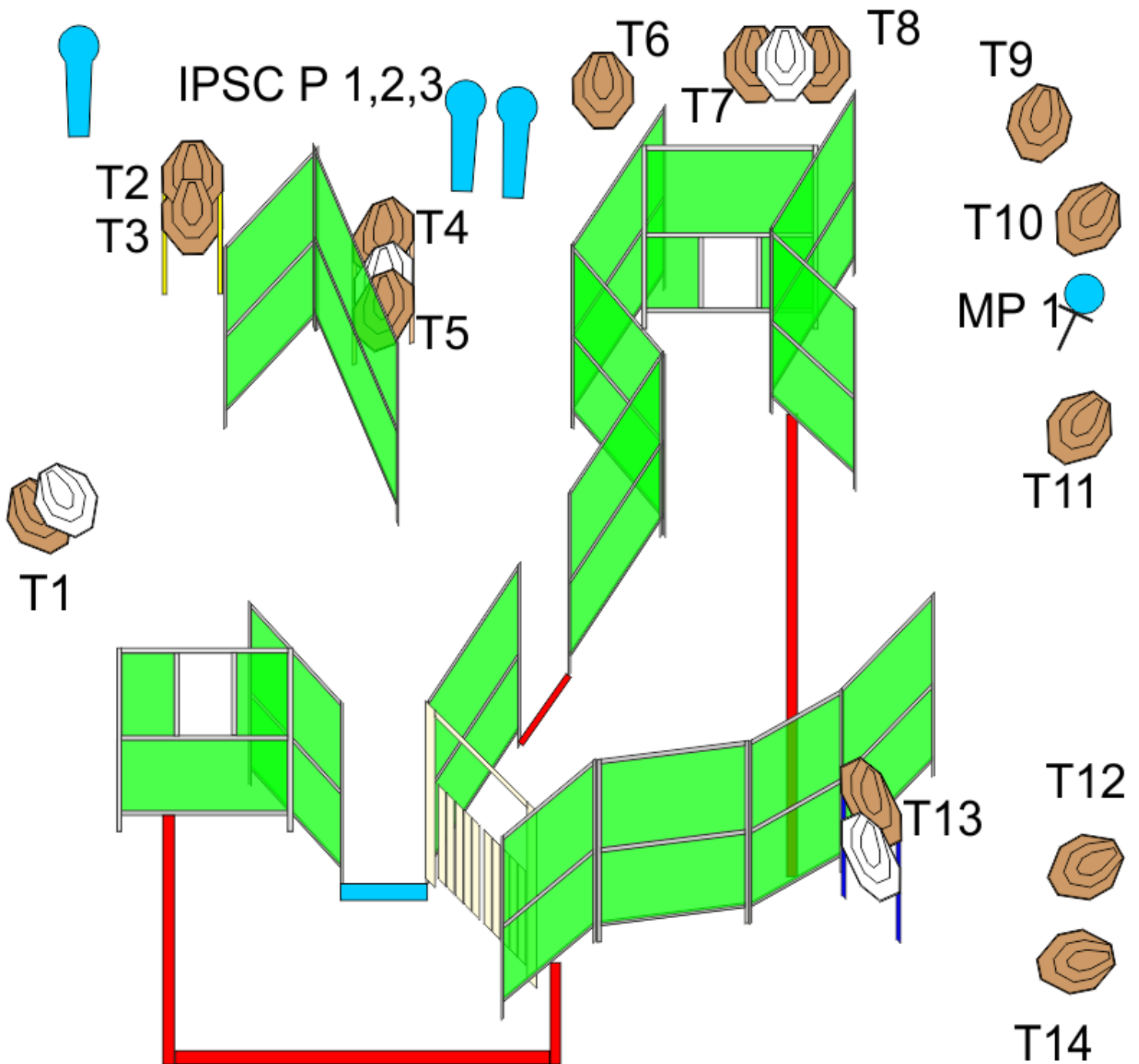

Targets:	14x IPSC Targets, 3x IPSC Poppers, 1x Metal Plate
Rounds to be scored:	32
Starting position:	The shooter is standing inside the marked area.
Handgun Ready condition:	
Procedure:	After audible signal engage the targets. Toes touching blue line.
Safe angles of fire:	Reduced to the height of the backstops.

STAGE 15 box 19

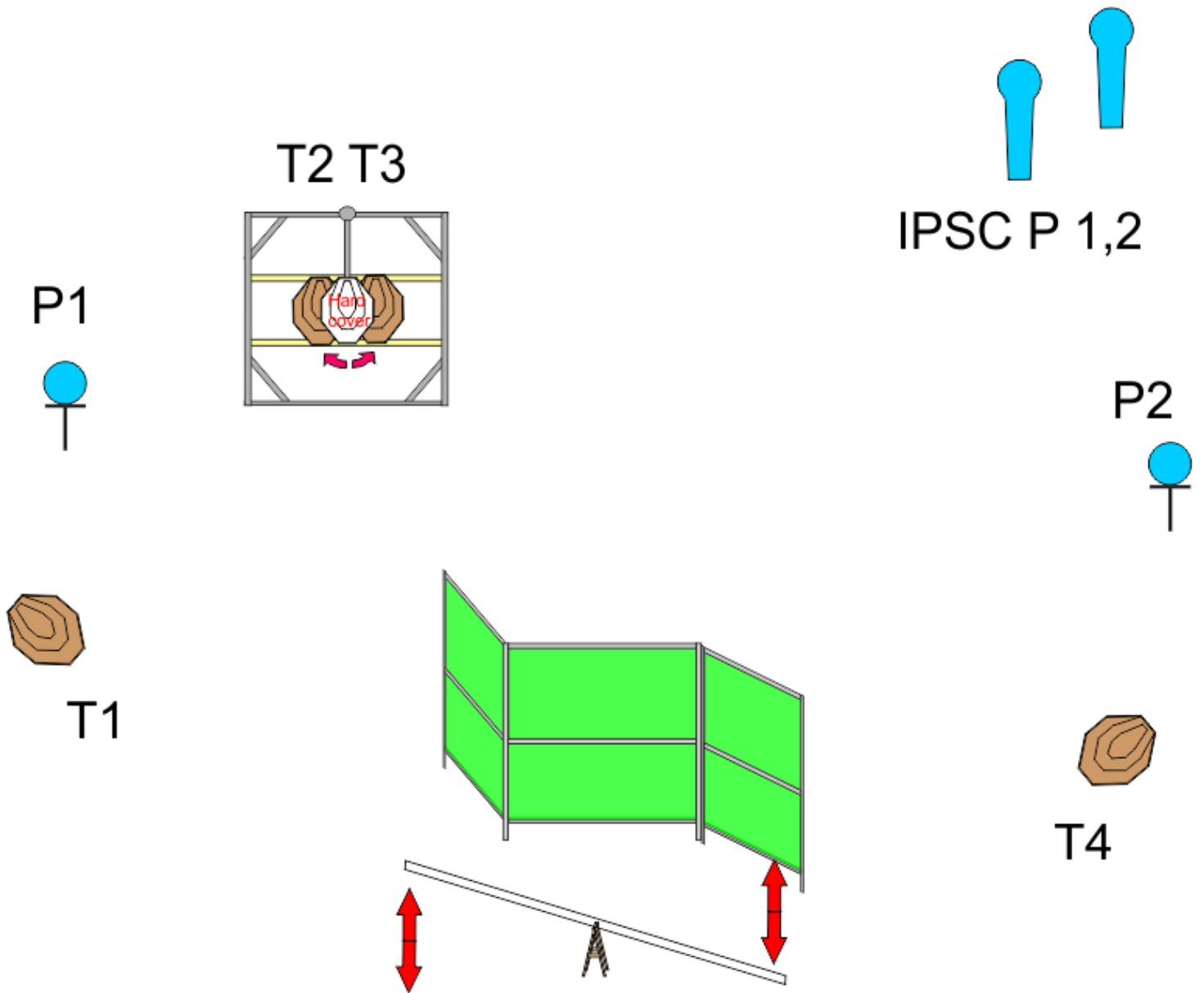

Targets:	4x IPSC Targets, 2x IPSC Poppers, 2x Metal Plates
Rounds to be scored:	12
Starting position:	The shooter is standing inside the marked area.
Handgun Ready condition:	
Procedure:	After audible signal engage the targets. Swing activates NS. Targets will remain visible at rest.
Safe angles of fire:	Reduced to the height of the backstops.

STAGE 16 box 20

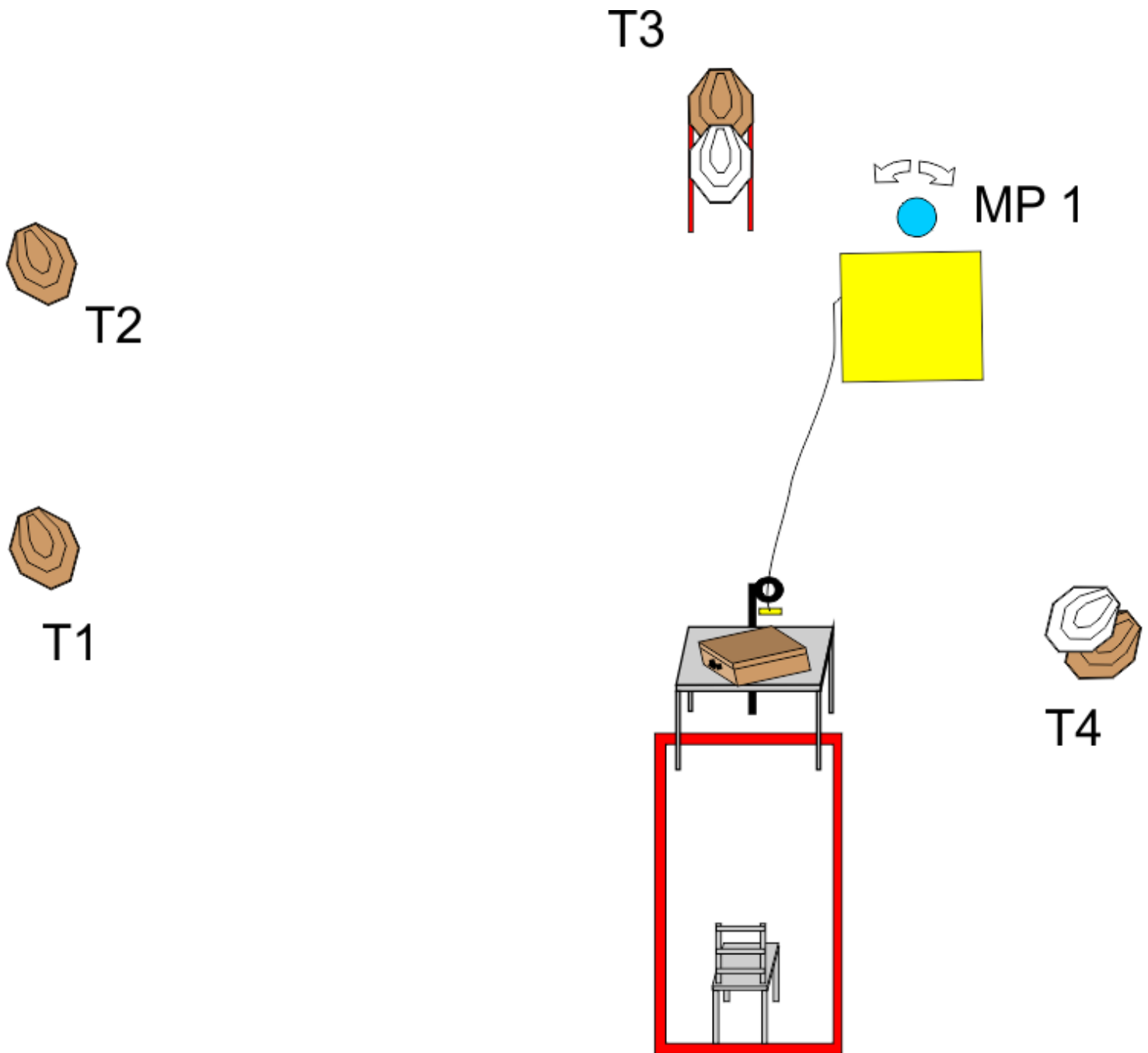

Targets:	4x IPSC Targets, 1x Metal Plate
Rounds to be scored:	9
Starting position:	The shooter is sitting inside the marked area.
Handgun Ready condition:	Chamber and magwell empty, all magazines are in the trunk, none on the belt.
Procedure:	After audible signal engage the targets, Rod activates MP 1. MP1 will remain visible at rest.
Safe angles of fire:	Reduced to the height of the backstops.

STAGE 17 box 21

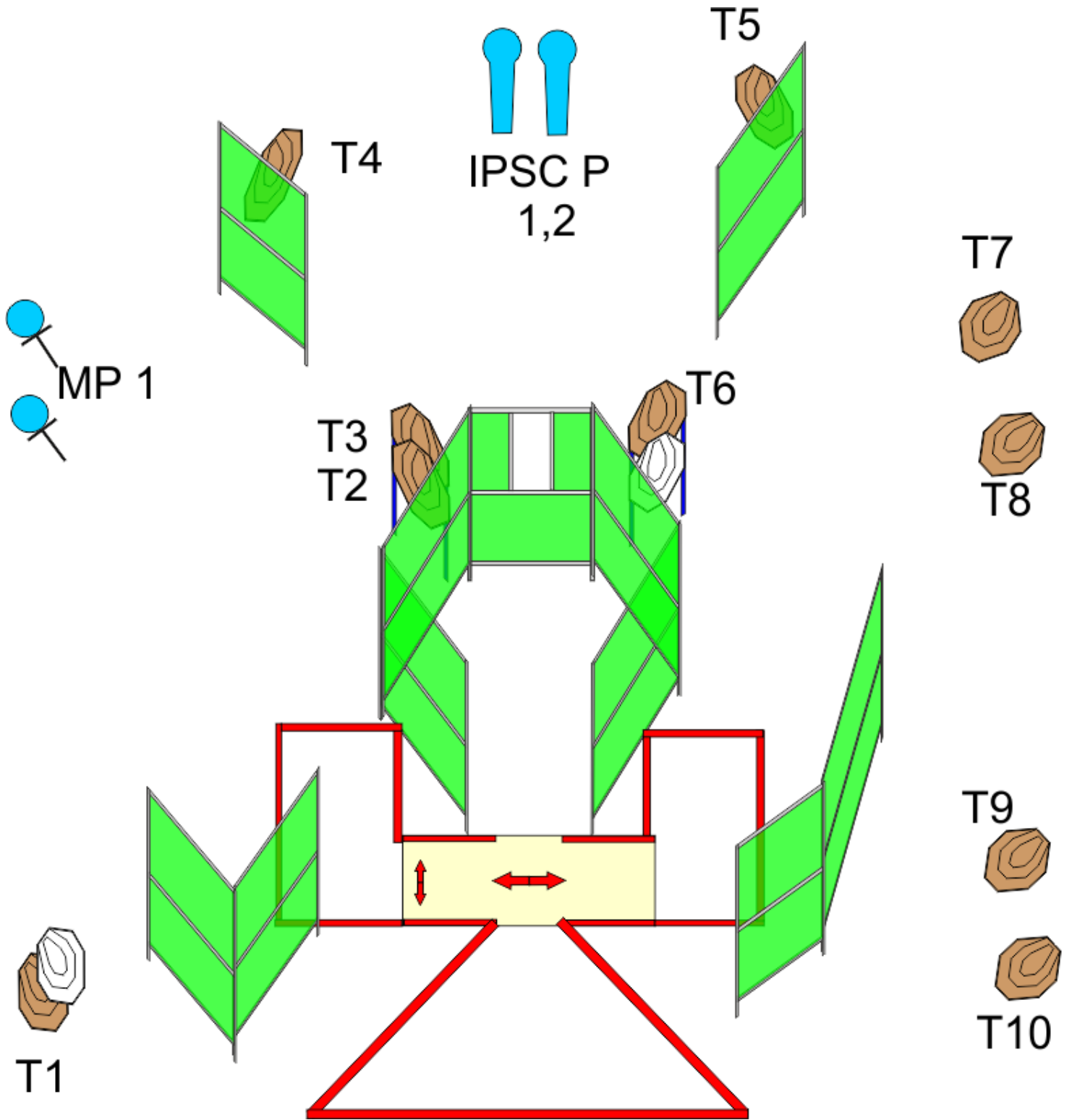

Targets:	10x IPSC Targets, 2x IPSC Poppers, 2x Metal Plates
Rounds to be scored:	24
Starting position:	The shooter is standing inside the marked area.
Handgun Ready condition:	
Procedure:	After audible signal engage the targets,
Safe angles of fire:	Reduced to the height of the backstops.

STAGE 18 box 22

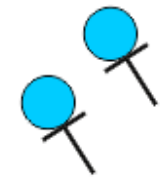

MP 1,2



T2

T3



T4



T1

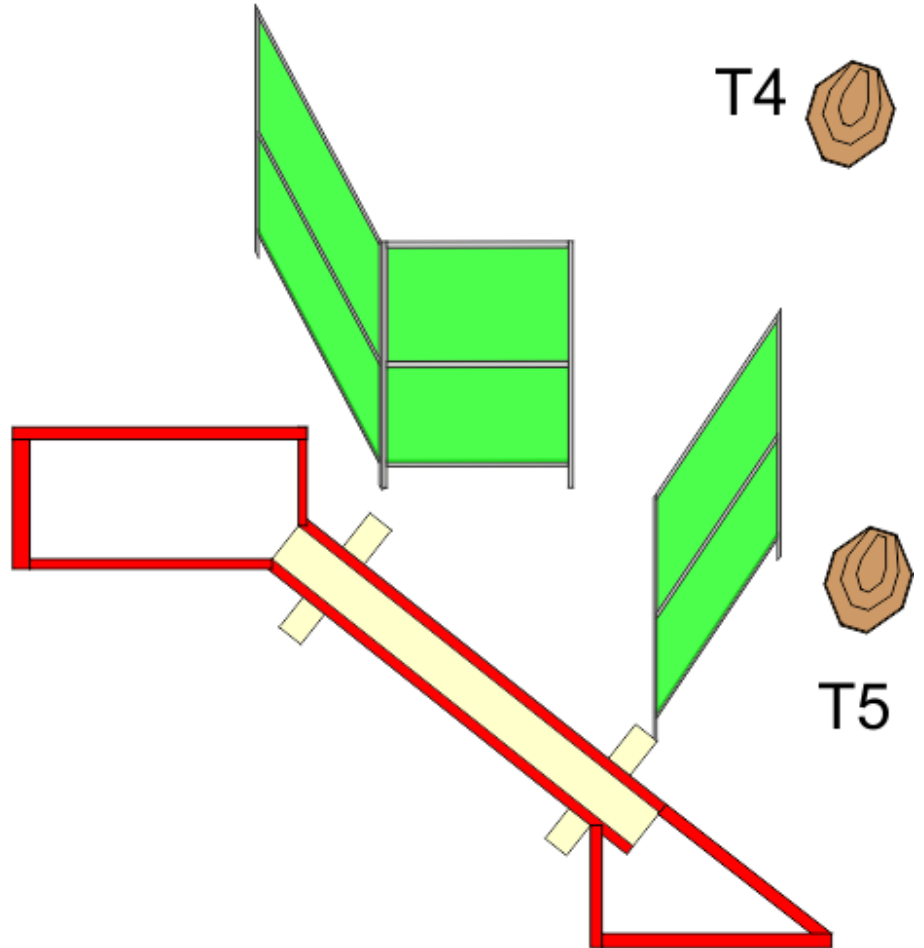

Targets:	5x IPSC Targets, 2x Metal Plates
Rounds to be scored:	12
Starting position:	The shooter is standing inside the marked area.
Handgun Ready condition:	
Procedure:	After audible signal engage the targets.
Safe angles of fire:	Reduced to the height of the backstops.

STAGE 19 box 23

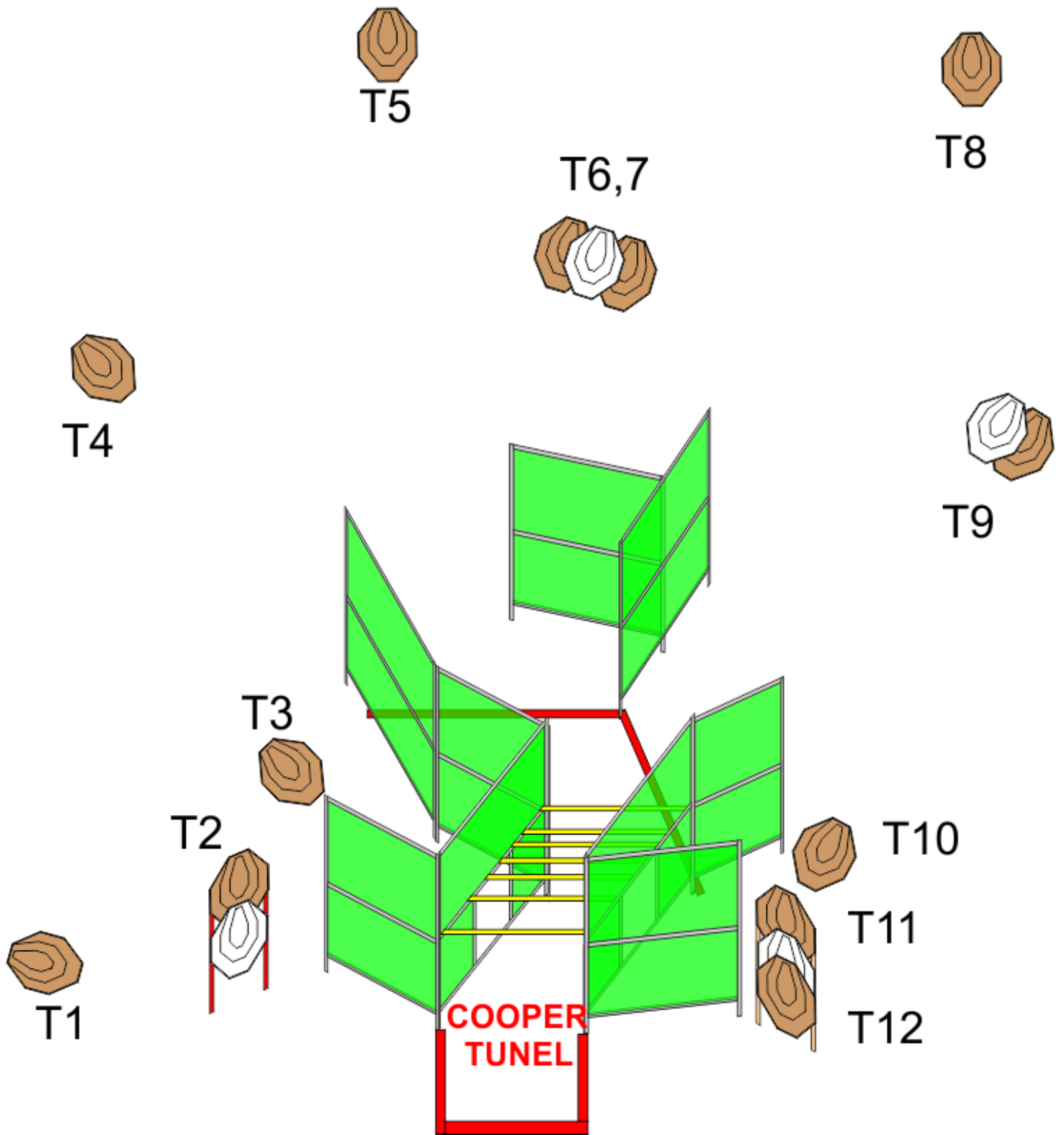

Targets:	12x IPSC Targets
Rounds to be scored:	24
Starting position:	The shooter is standing inside the marked area.
Handgun Ready condition:	
Procedure:	After audible signal engage the targets
Safe angles of fire:	Reduced to the height of the backstops.

STAGE 20 box 24

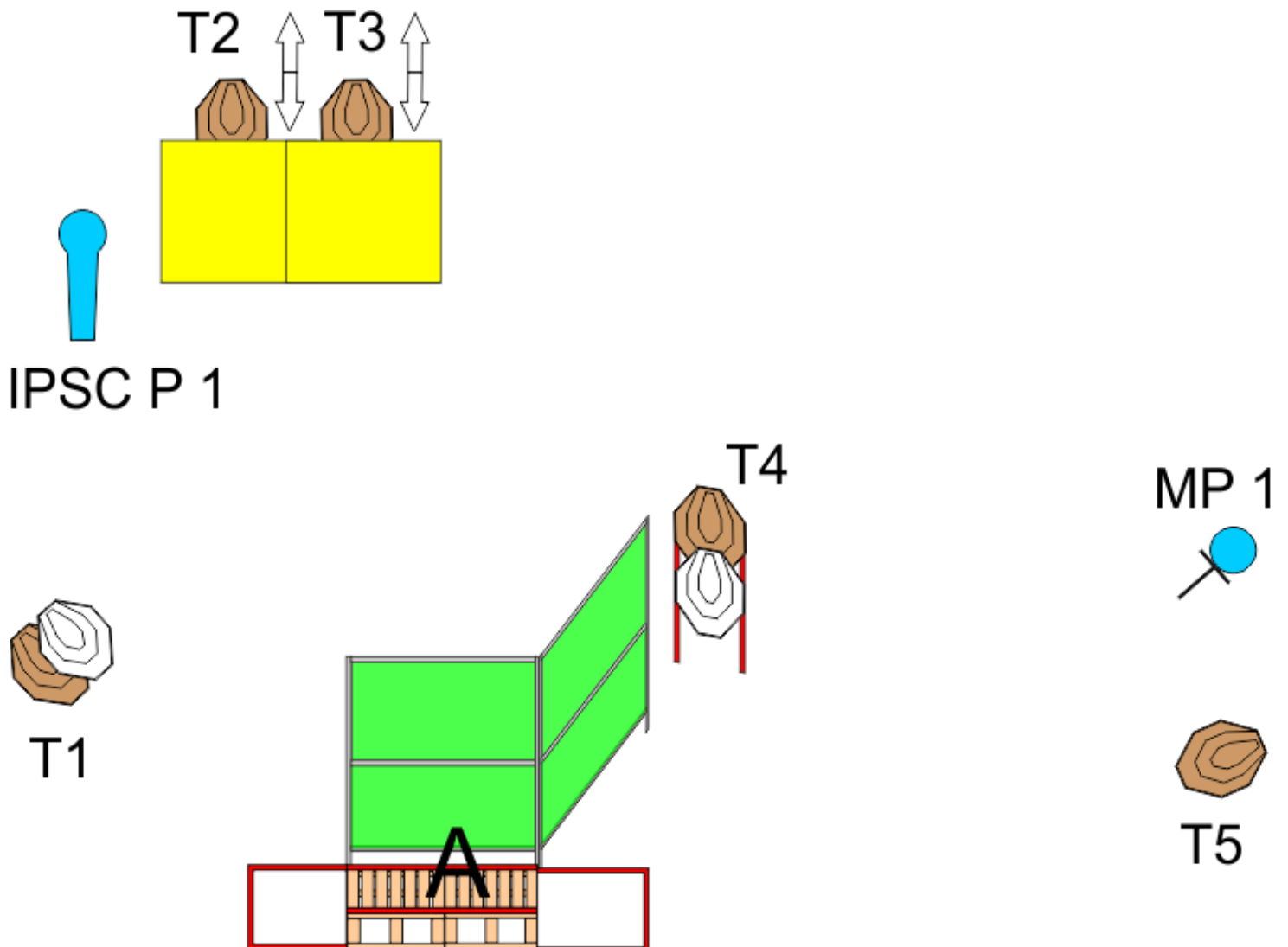

Targets:	5x IPSC Targets, 1x IPSC Popper, 1x Metal Plate
Rounds to be scored:	12
Starting position:	The shooter is standing inside the marked area.
Handgun Ready condition:	Magazine inserted, chamber is empty
Procedure:	After audible signal engage the targets, IPSC Popper 1 activates T2, T2 activates T3, targets will remain visible at rest.
Safe angles of fire:	Reduced to the height of the backstops.